

LM6172

Dual High Speed, Low Power, Low Distortion, Voltage Feedback Amplifiers

General Description

The LM6172 is a dual high speed voltage feedback amplifier. It is unity-gain stable and provides excellent DC and AC performance. With 100MHz unity-gain bandwidth, 3000V/ μ s slew rate and 50mA of output current per channel, the LM6172 offers high performance in dual amplifiers; yet it only consumes 2.3mA of supply current each channel.

The LM6172 operates on $\pm 15V$ power supply for systems requiring large voltage swings, such as ADSL, scanners and ultrasound equipment. It is also specified at $\pm 5V$ power supply for low voltage applications such as portable video systems.

The LM6172 is built with National's advanced VIP™ III (Vertically Integrated PNP) complementary bipolar process. See the LM6171 datasheet for a single amplifier with these same features.

Features

(Typical Unless Otherwise Noted)

- Easy to Use Voltage Feedback Topology
- High Slew Rate 3000V/ μ s
- Wide Unity-Gain Bandwidth 100MHz
- Low Supply Current 2.3mA/Channel
- High Output Current 50mA/channel
- Specified for $\pm 15V$ and $\pm 5V$ Operation

Applications

- Scanner I-to-V Converters
- ADSL/HDSL Drivers
- Multimedia Broadcast Systems
- Video Amplifiers
- NTSC, PAL® and SECAM Systems
- ADC/DAC Buffers
- Pulse Amplifiers and Peak Detectors

LM6172 Driving Capacitive Load

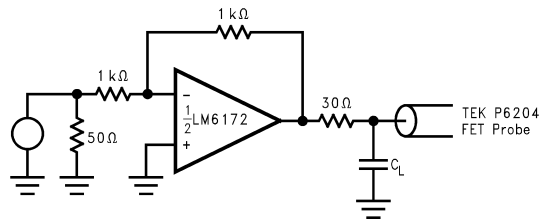
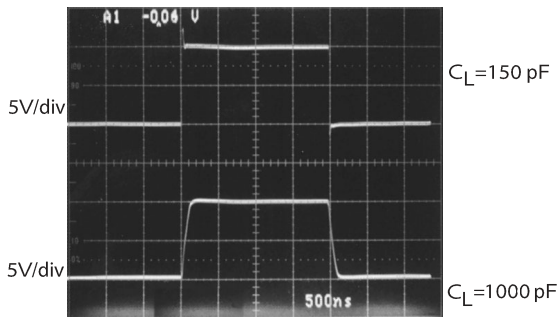

01258144

Connection Diagram

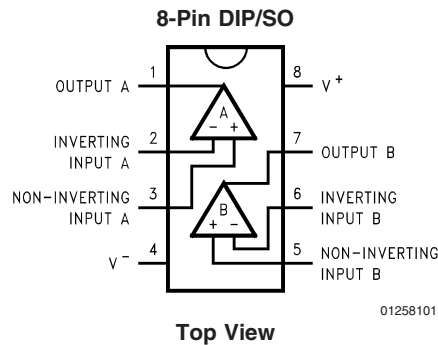

01258101

VIP™ is a trademark of National Semiconductor Corporation.
PAL® is a registered trademark of and used under license from Advanced Micro Devices, Inc.

Ordering Information

| Package | Temperature Range | | Transport Media | NSC Drawing |
|------------------------|------------------------------|-----------------------------|-----------------|-------------|
| | Industrial -40°C to +85°C | Military -55°C to +125°C | | |
| 8-Pin DIP | LM6172IN | | Rails | N08E |
| 8-Pin CDIP | LM6172AMJ-QML | 5962-95604 | Rails | J08A |
| 16-Pin Ceramic SOIC | LM6172AMWG-QML | 5962-95604 | Trays | WG16A |
| 8-Pin Small Outline | LM6172IM | | Rails | M08A |
| | LM6172IMX | | Tape and Reel | |

Absolute Maximum Ratings (Note 1)

If Military/Aerospace specified devices are required, please contact the National Semiconductor Sales Office/Distributors for availability and specifications.

| | |
|-----------------------------------------|---------------------------------|
| ESD Tolerance (Note 2) | |
| Human Body Model | 3kV |
| Machine Model | 300V |
| Supply Voltage ($V^+ - V^-$) | 36V |
| Differential Input Voltage | $\pm 10V$ |
| Common Mode Voltage Range | $V^+ +0.3V$ to $V^- -0.3V$ |
| Input Current | $\pm 10mA$ |
| Output Short Circuit to Ground (Note 3) | Continuous |
| Storage Temp. Range | $-65^\circ C$ to $+150^\circ C$ |
| Maximum Junction Temperature (Note 4) | $150^\circ C$ |

Soldering Information

| | |
|-----------------------------------------|---------------|
| Infrared or Convection Reflow (20 sec.) | $235^\circ C$ |
| Wave Soldering Lead Temp (10 sec.) | $260^\circ C$ |

Operating Ratings (Note 1)

| | |
|--------------------------------------|--------------------------------|
| Supply Voltage | $5.5V \leq V_S \leq 36V$ |
| Operating Temperature Range LM6172I | $-40^\circ C$ to $+85^\circ C$ |
| Thermal Resistance (θ_{JA}) | |
| N Package, 8-Pin Molded DIP | $95^\circ C/W$ |
| M Package, 8-Pin Surface Mount | $160^\circ C/W$ |

$\pm 15V$ DC Electrical Characteristics

Unless otherwise specified, all limits guaranteed for $T_J = 25^\circ C$, $V^+ = +15V$, $V^- = -15V$, $V_{CM} = 0V$, and $R_L = 1k\Omega$. **Boldface** limits apply at the temperature extremes

| Symbol | Parameter | Conditions | Typ (Note 5) | LM6172I Limit (Note 6) | Units |
|-------------|------------------------------------------------|-----------------------------|--------------|------------------------|------------------|
| V_{OS} | Input Offset Voltage | | 0.4 | 3 4 | mV max |
| TC V_{OS} | Input Offset Voltage Average Drift | | 6 | | $\mu V/^\circ C$ |
| I_B | Input Bias Current | | 1.2 | 3 4 | μA max |
| I_{OS} | Input Offset Current | | 0.02 | 2 3 | μA max |
| R_{IN} | Input Resistance | Common Mode | 40 | | $M\Omega$ |
| | | Differential Mode | 4.9 | | |
| R_O | Open Loop Output Resistance | | 14 | | Ω |
| CMRR | Common Mode Rejection Ratio | $V_{CM} = \pm 10V$ | 110 | 70 65 | dB min |
| PSRR | Power Supply Rejection Ratio | $V_S = \pm 15V$ to $\pm 5V$ | 95 | 75 70 | dB min |
| V_{CM} | Input Common Mode Voltage Range | CMRR $\geq 60dB$ | ± 13.5 | | V |
| A_V | Large Signal Voltage Gain (Note 7) | $R_L = 1k\Omega$ | 86 | 80 75 | dB min |
| | | $R_L = 100\Omega$ | 78 | 65 60 | dB min |
| V_O | Output Swing | $R_L = 1k\Omega$ | 13.2 | 12.5 12 | V min |
| | | | -13.1 | -12.5 -12 | V max |
| | | $R_L = 100\Omega$ | 9 | 6 5 | V min |
| | | | -8.5 | -6 -5 | V max |
| | Continuous Output Current (Open Loop) (Note 8) | Sourcing, $R_L = 100\Omega$ | 90 | 60 50 | mA min |

±15V DC Electrical Characteristics (Continued)

Unless otherwise specified, all limits guaranteed for $T_J = 25^\circ\text{C}$, $V^+ = +15\text{V}$, $V^- = -15\text{V}$, $V_{CM} = 0\text{V}$, and $R_L = 1\text{k}\Omega$. **Boldface** limits apply at the temperature extremes

| Symbol | Parameter | Conditions | Typ (Note 5) | LM6172I Limit (Note 6) | Units |
|----------|------------------------------|----------------------------|-----------------|------------------------------|-----------|
| | | Sinking, $R_L = 100\Omega$ | -85 | -60 -50 | mA max |
| I_{SC} | Output Short Circuit Current | Sourcing | 107 | | mA |
| | | Sinking | -105 | | mA |
| I_S | Supply Current | Both Amplifiers | 4.6 | 8 | mA |
| | | | | 9 | max |

±15V AC Electrical Characteristics

Unless otherwise specified, $T_J = 25^\circ\text{C}$, $V^+ = +15\text{V}$, $V^- = -15\text{V}$, $V_{CM} = 0\text{V}$, and $R_L = 1\text{k}\Omega$

| Symbol | Parameter | Conditions | LM6172I Typ (Note 5) | Units |
|----------|--------------------------------------|---------------------------------------------------------------|----------------------------|--------------------------------------|
| SR | Slew Rate | $A_V = +2$, $V_{IN} = 13 V_{PP}$ | 3000 | V/ μs |
| | | $A_V = +2$, $V_{IN} = 10 V_{PP}$ | 2500 | V/ μs |
| | Unity-Gain Bandwidth | | 100 | MHz |
| | -3 dB Frequency | $A_V = +1$ | 160 | MHz |
| | | $A_V = +2$ | 62 | MHz |
| | Bandwidth Matching between Channels | | 2 | MHz |
| ϕ_m | Phase Margin | | 40 | Deg |
| t_s | Settling Time (0.1%) | $A_V = -1$, $V_{OUT} = \pm 5\text{V}$, $R_L = 500\Omega$ | 65 | ns |
| A_D | Differential Gain (Note 9) | | 0.28 | % |
| ϕ_D | Differential Phase (Note 9) | | 0.6 | Deg |
| e_n | Input-Referred Voltage Noise | $f = 1\text{kHz}$ | 12 | $\frac{\text{pA}}{\sqrt{\text{Hz}}}$ |
| | | | | |
| i_n | Input-Referred Current Noise | $f = 1\text{kHz}$ | 1 | $\frac{\text{nV}}{\sqrt{\text{Hz}}}$ |
| | | | | |
| | Second Harmonic Distortion (Note 10) | $f = 10\text{kHz}$ | -110 | dB |
| | | $f = 5\text{MHz}$ | -50 | dB |
| | Third Harmonic Distortion (Note 10) | $f = 10\text{kHz}$ | -105 | dB |
| | | $f = 5\text{MHz}$ | -50 | dB |

±5V DC Electrical Characteristics

Unless otherwise specified, all limits guaranteed for $T_J = 25^\circ\text{C}$, $V^+ = +5\text{V}$, $V^- = -5\text{V}$, $V_{CM} = 0\text{V}$, and $R_L = 1\text{k}\Omega$. **Boldface** limits apply at the temperature extremes

| Symbol | Parameter | Conditions | Typ (Note 5) | LM6172I Limit (Note 6) | Units |
|-------------|------------------------------------|------------|-----------------|------------------------------|------------------------------|
| V_{OS} | Input Offset Voltage | | 0.1 | 3 | mV |
| | | | | 4 | max |
| TC V_{OS} | Input Offset Voltage Average Drift | | 4 | | $\mu\text{V}/^\circ\text{C}$ |
| I_B | Input Bias Current | | 1.4 | 2.5 | μA |
| | | | | 3.5 | max |
| I_{OS} | Input Offset Current | | 0.02 | 1.5 | μA |

±5V DC Electrical Characteristics (Continued)

Unless otherwise specified, all limits guaranteed for $T_J = 25^\circ\text{C}$, $V^+ = +5\text{V}$, $V^- = -5\text{V}$, $V_{CM} = 0\text{V}$, and $R_L = 1\text{ k}\Omega$. **Boldface** limits apply at the temperature extremes

| Symbol | Parameter | Conditions | Typ (Note 5) | LM6172I Limit (Note 6) | Units |
|----------|---------------------------------------------------|------------------------------------------|-----------------|------------------------------|-----------|
| | | | | 2.2 | max |
| R_{IN} | Input Resistance | Common Mode | 40 | | $M\Omega$ |
| | | Differential Mode | 4.9 | | |
| R_O | Output Resistance | | 14 | | Ω |
| CMRR | Common Mode Rejection Ratio | $V_{CM} = \pm 2.5\text{V}$ | 105 | 70 | dB |
| | | | | 65 | min |
| PSRR | Power Supply Rejection Ratio | $V_S = \pm 15\text{V to } \pm 5\text{V}$ | 95 | 75 | dB |
| | | | | 70 | min |
| V_{CM} | Input Common Mode Voltage Range | CMRR $\geq 60\text{dB}$ | ± 3.7 | | V |
| A_V | Large Signal Voltage Gain (Note 7) | $R_L = 1\text{ k}\Omega$ | 82 | 70 | dB |
| | | | | 65 | min |
| | | $R_L = 100\Omega$ | 78 | 65 | dB |
| | | | | 60 | min |
| V_O | Output Swing | $R_L = 1\text{ k}\Omega$ | 3.4 | 3.1 | V |
| | | | | 3 | min |
| | | | -3.3 | -3.1 | V |
| | | | -3 | max | |
| | | $R_L = 100\Omega$ | 2.9 | 2.5 | V |
| | | | | 2.4 | min |
| | | | -2.7 | -2.4 | V |
| | | | | -2.3 | max |
| | Continuous Output Current (Open Loop) (Note 8) | Sourcing, $R_L = 100\Omega$ | 29 | 25 | mA |
| | | | | 24 | min |
| | | Sinking, $R_L = 100\Omega$ | -27 | -24 | mA |
| | | | | -23 | max |
| I_{SC} | Output Short Circuit Current | Sourcing | 93 | | mA |
| | | Sinking | -72 | | mA |
| I_S | Supply Current | Both Amplifiers | 4.4 | 6 | mA |
| | | | | 7 | max |

±5V AC Electrical Characteristics

Unless otherwise specified, $T_J = 25^\circ\text{C}$, $V^+ = +5\text{V}$, $V^- = -5\text{V}$, $V_{CM} = 0\text{V}$, and $R_L = 1\text{ k}\Omega$.

| Symbol | Parameter | Conditions | LM61722 Typ (Note 5) | Units |
|----------|-----------------------------|---------------------------------------------------------------|----------------------------|------------------|
| SR | Slew Rate | $A_V = +2$, $V_{IN} = 3.5 V_{PP}$ | 750 | V/ μs |
| | Unity-Gain Bandwidth | | 70 | MHz |
| | -3 dB Frequency | $A_V = +1$ | 130 | MHz |
| | | $A_V = +2$ | 45 | MHz |
| ϕ_m | Phase Margin | | 57 | Deg |
| t_s | Settling Time (0.1%) | $A_V = -1$, $V_{OUT} = \pm 1\text{V}$, $R_L = 500\Omega$ | 72 | ns |
| A_D | Differential Gain (Note 9) | | 0.4 | % |
| ϕ_D | Differential Phase (Note 9) | | 0.7 | Deg |

±5V AC Electrical Characteristics (Continued)

Unless otherwise specified, $T_J = 25^\circ\text{C}$, $V^+ = +5\text{V}$, $V^- = -5\text{V}$, $V_{CM} = 0\text{V}$, and $R_L = 1\text{ k}\Omega$.

| Symbol | Parameter | Conditions | LM61722 Typ (Note 5) | Units |
|--------|-----------------------------------------|--------------------|----------------------------|--------------------------------------|
| e_n | Input-Referred Voltage Noise | $f = 1\text{kHz}$ | 11 | $\frac{\text{nV}}{\sqrt{\text{Hz}}}$ |
| i_n | Input-Referred Current Noise | $f = 1\text{kHz}$ | 1 | $\frac{\text{pA}}{\sqrt{\text{Hz}}}$ |
| | Second Harmonic Distortion (Note 10) | $f = 10\text{kHz}$ | -110 | dB |
| | | $f = 5\text{MHz}$ | -48 | dB |
| | Third Harmonic Distortion (Note 10) | $f = 10\text{kHz}$ | -105 | dB |
| | | $f = 5\text{MHz}$ | -50 | dB |

Note 1: Absolute Maximum Ratings indicate limits beyond which damage to the device may occur. Operating Ratings indicate conditions for which the device is intended to be functional, but specific performance is not guaranteed. For guaranteed specifications and the test conditions, see the Electrical Characteristics.

Note 2: Human body model, 1.5k Ω in series with 100pF. Machine Model, 200 Ω in series with 100pF.

Note 3: Continuous short circuit operation can result in exceeding the maximum allowed junction temperature of 150°C.

Note 4: The maximum power dissipation is a function of $T_{J(max)}$, θ_{JA} , and T_A . The maximum allowable power dissipation at any ambient temperature is $P_D = (T_{J(max)} - T_A)/\theta_{JA}$. All numbers apply for packages soldered directly into a PC board.

Note 5: Typical Values represent the most likely parametric norm.

Note 6: All limits are guaranteed by testing or statistical analysis.

Note 7: Large signal voltage gain is the total output swing divided by the input signal required to produce that swing. For $V_S = \pm 15\text{V}$, $V_{OUT} = \pm 5\text{V}$. For $V_S = \pm 5\text{V}$, $V_{OUT} = \pm 1\text{V}$.

Note 8: The open loop output current is the output swing with the 100 Ω load resistor divided by that resistor.

Note 9: Differential gain and phase are measured with $A_V = +2$, $V_{IN} = 1\text{ V}_{PP}$ at 3.58MHz and both input and output 75 Ω terminated.

Note 10: Harmonics are measured with $A_V = +2$, $V_{IN} = 1\text{ V}_{PP}$ and $R_L = 100\Omega$.

Typical Performance Characteristics unless otherwise noted, $T_A = 25^\circ\text{C}$

Supply Voltage vs. Supply Current

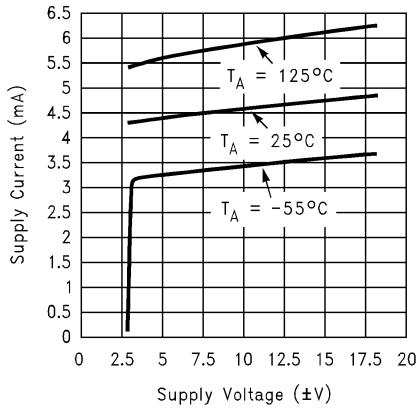

01258114

Supply Current vs. Temperature

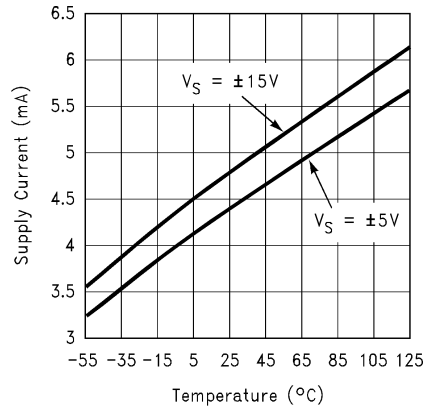

01258115

Input Offset Voltage vs. Temperature

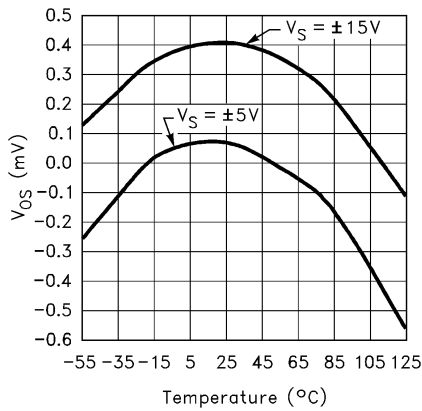

01258116

Input Bias Current vs. Temperature

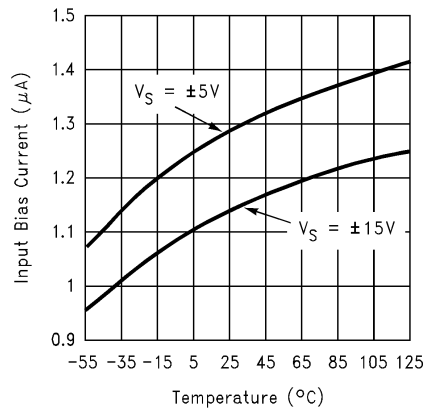

01258117

Short Circuit Current vs. Temperature (Sourcing)

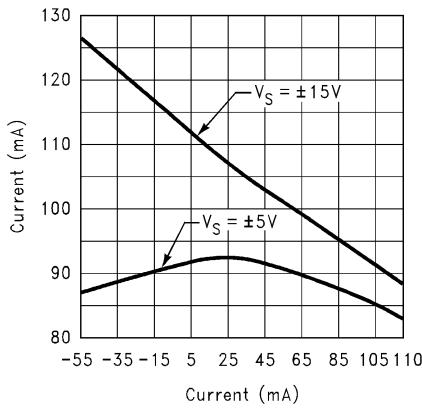

01258118

Short Circuit Current vs. Temperature (Sinking)

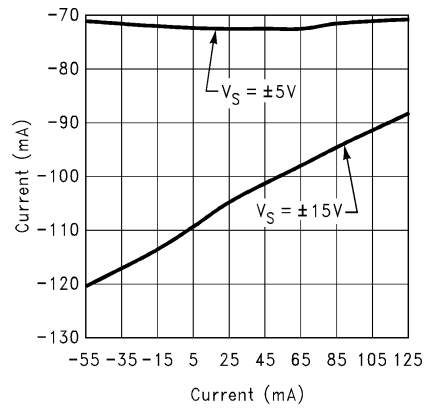

01258135

Typical Performance Characteristics unless otherwise noted, $T_A = 25^\circ\text{C}$ (Continued)

Output Voltage vs. Output Current
($V_S = \pm 15\text{V}$)

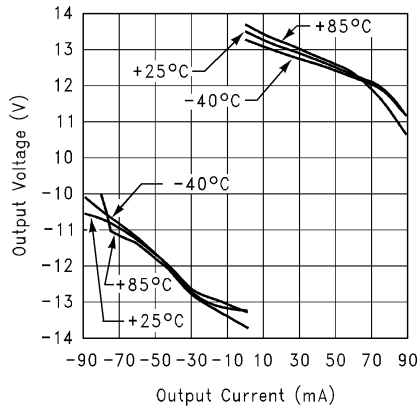

01258136

Output Voltage vs. Output Current
($V_S = \pm 5\text{V}$)

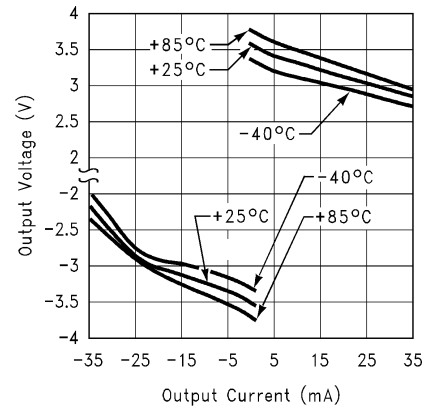

01258137

CMRR vs. Frequency

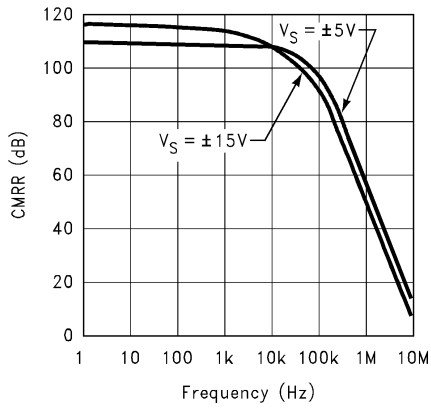

01258119

PSRR vs. Frequency

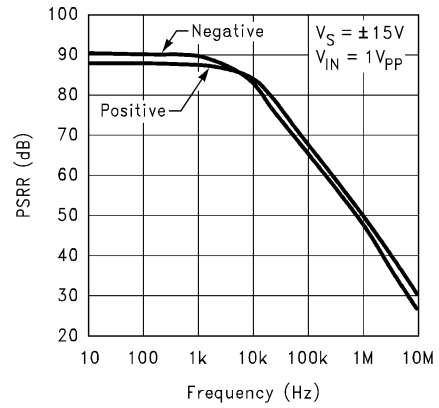

01258120

PSRR vs. Frequency

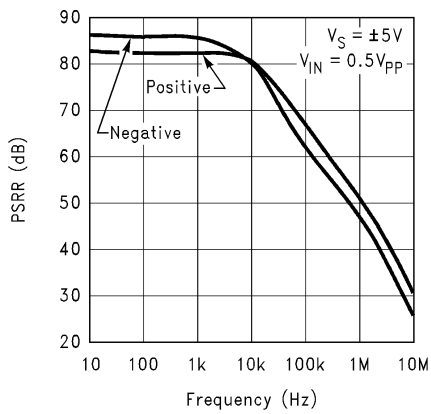

01258133

Open-Loop Frequency Response

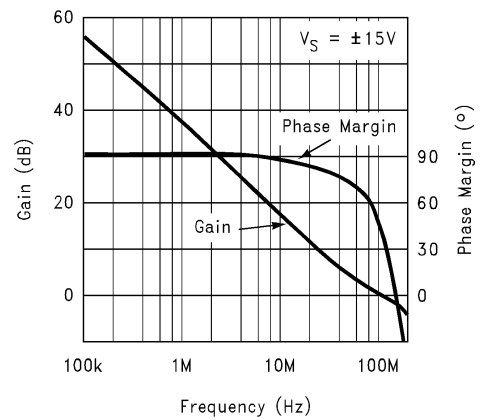

01258121

Typical Performance Characteristics unless otherwise noted, $T_A = 25^\circ\text{C}$ (Continued)

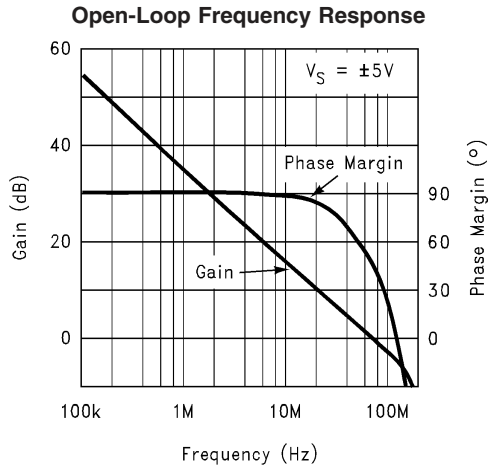

01258122

Gain-Bandwidth Product vs. Supply Voltage at Different Temperature

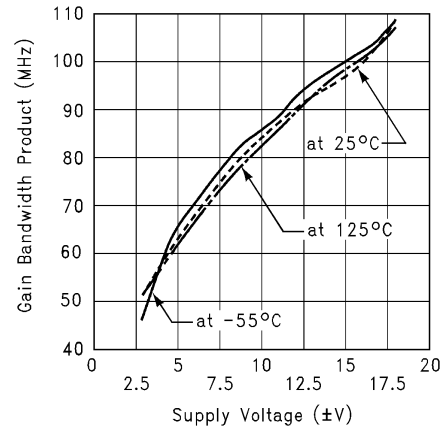

01258123

Large Signal Voltage Gain vs. Load

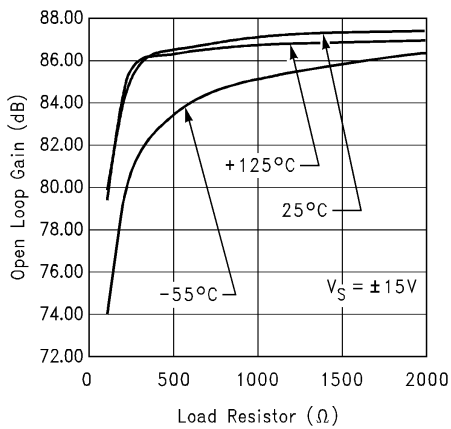

01258138

Large Signal Voltage Gain vs. Load

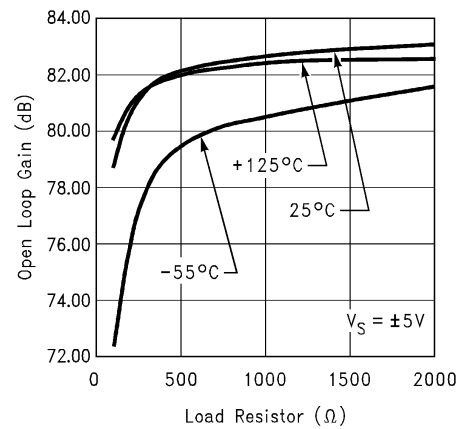

01258139

Input Voltage Noise vs. Frequency

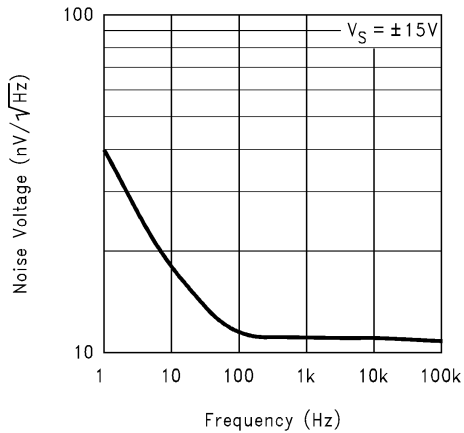

01258140

Input Voltage Noise vs. Frequency

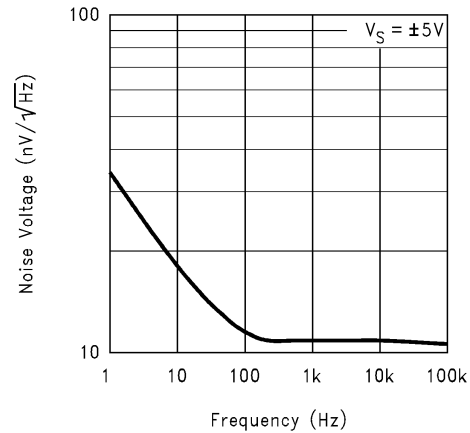

01258141

Typical Performance Characteristics unless otherwise noted, $T_A = 25^\circ\text{C}$ (Continued)

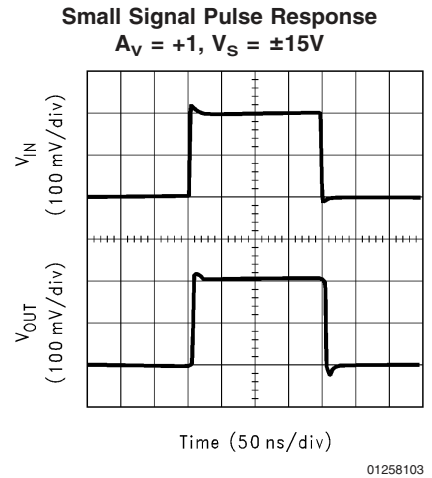
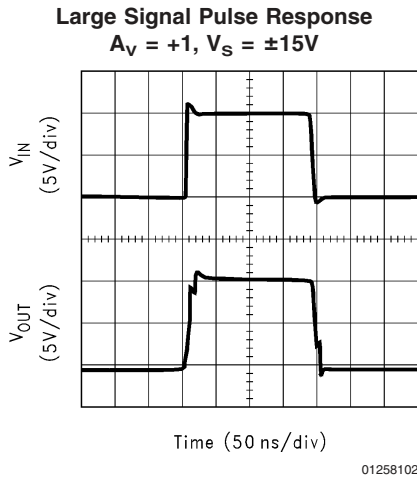
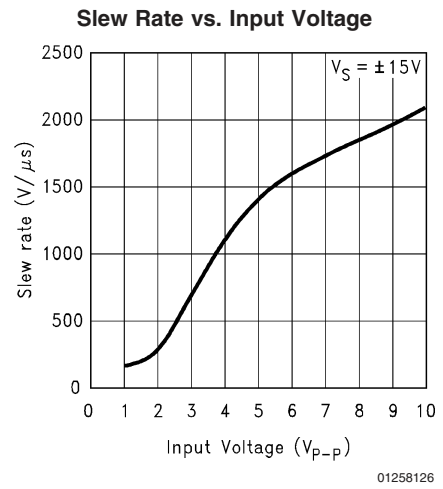
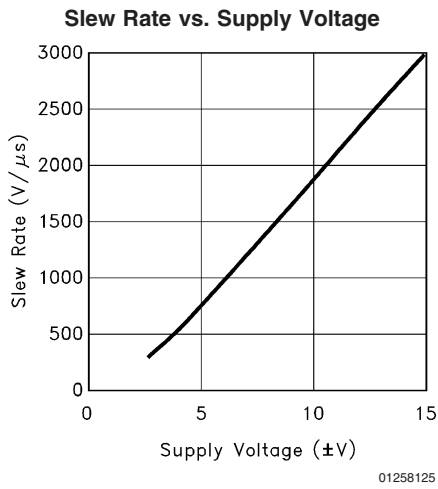
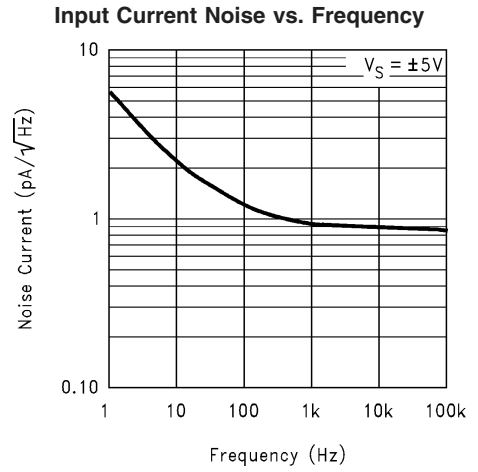
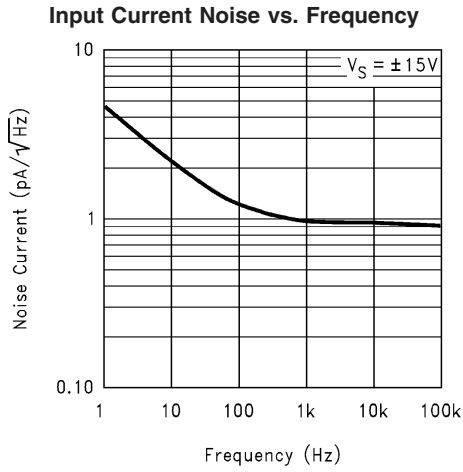

Typical Performance Characteristics

unless otherwise noted, $T_A = 25^\circ\text{C}$ (Continued)

Large Signal Pulse Response

$$A_V = +1, V_S = \pm 5\text{V}$$

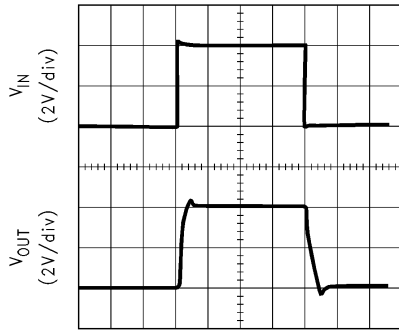

Time (50 ns/div)

01258104

Small Signal Pulse Response

$$A_V = +1, V_S = \pm 5\text{V}$$

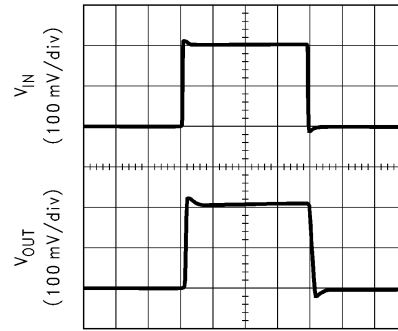

Time (50 ns/div)

01258105

Large Signal Pulse Response

$$A_V = +2, V_S = \pm 15\text{V}$$

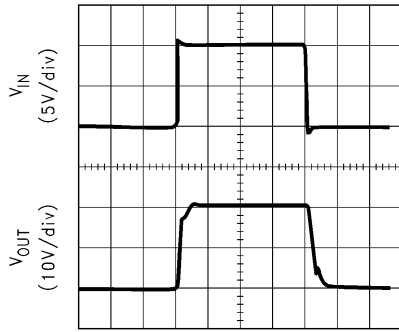

Time (50 ns/div)

01258106

Small Signal Pulse Response

$$A_V = +2, V_S = \pm 15\text{V}$$

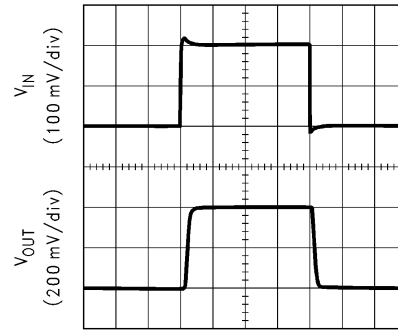

Time (50 ns/div)

01258107

Large Signal Pulse Response

$$A_V = +2, V_S = \pm 5\text{V}$$

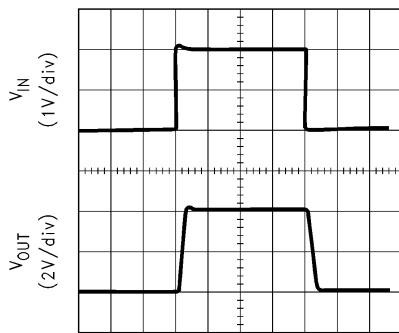

Time (50 ns/div)

01258108

Small Signal Pulse Response

$$A_V = +2, V_S = \pm 5\text{V}$$

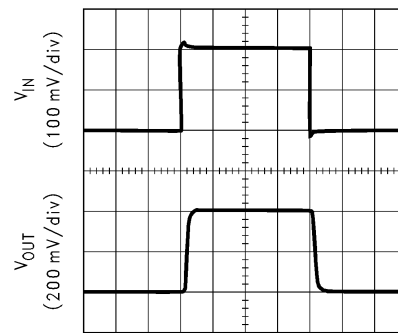

Time (50 ns/div)

01258109

Typical Performance Characteristics unless otherwise noted, $T_A = 25^\circ\text{C}$ (Continued)

Large Signal Pulse Response
 $A_V = -1, V_S = \pm 15\text{V}$

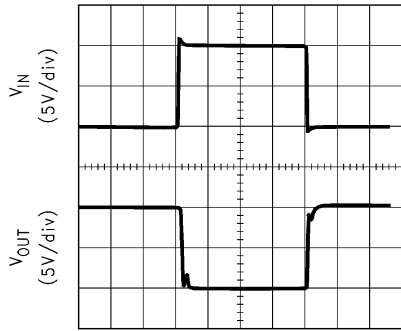

Time (50 ns/div)

01258110

Small Signal Pulse Response
 $A_V = -1, V_S = \pm 15\text{V}$

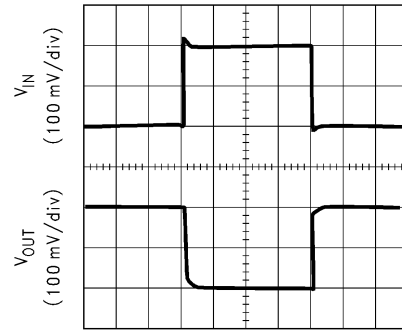

Time (50 ns/div)

01258111

Large Signal Pulse Response
 $A_V = -1, V_S = \pm 5\text{V}$

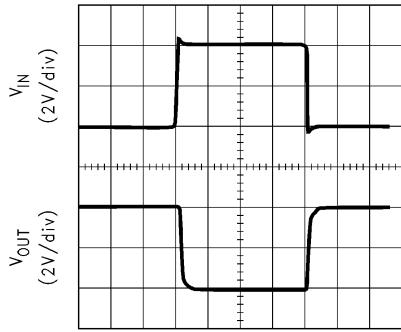

Time (50 ns/div)

01258112

Small Signal Pulse Response
 $A_V = -1, V_S = \pm 5\text{V}$

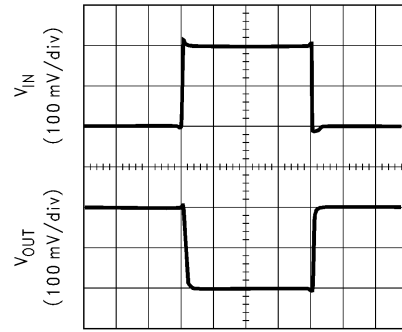

Time (50 ns/div)

01258113

Closed Loop Frequency Response vs. Supply Voltage
 $(A_V = +1)$

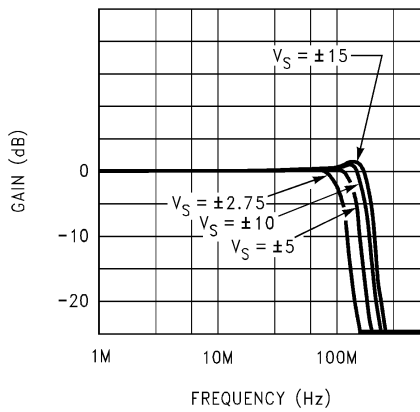

01258128

Closed Loop Frequency Response vs. Supply Voltage
 $(A_V = +2)$

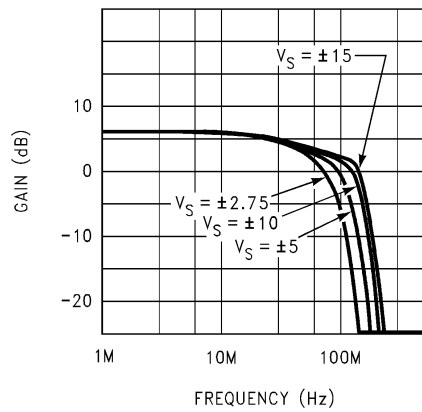

01258129

Typical Performance Characteristics unless otherwise noted, $T_A = 25^\circ\text{C}$ (Continued)

Harmonic Distortion vs. Frequency
($V_S = \pm 15\text{V}$)

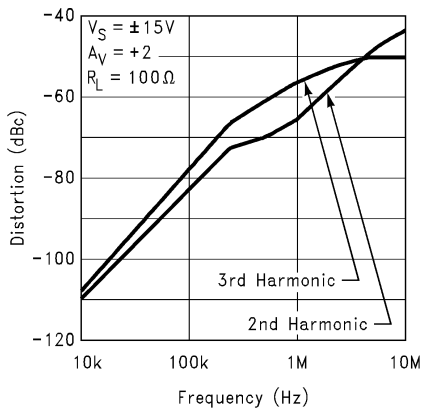

Harmonic Distortion vs. Frequency
($V_S = \pm 5\text{V}$)

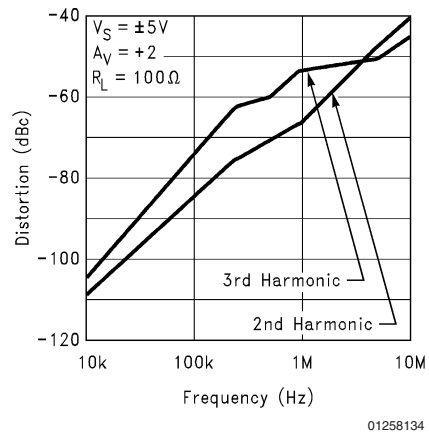

Crosstalk Rejection vs. Frequency

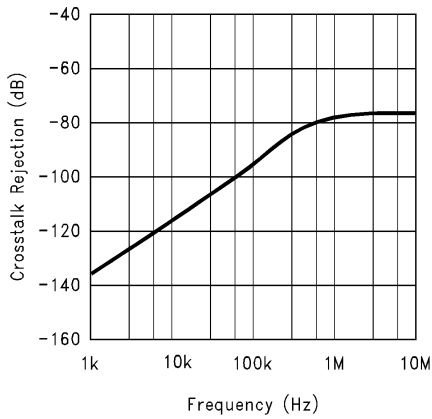

Maximum Power Dissipation vs. Ambient Temperature

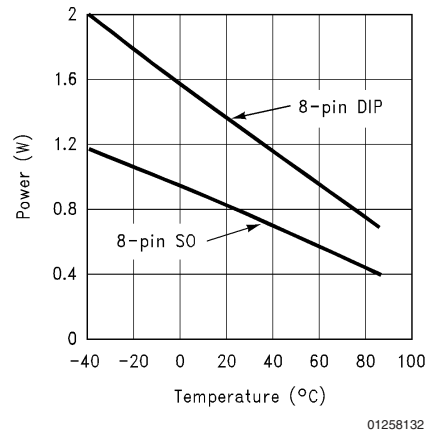

LM6172 Simplified Schematic (Each Amplifier)

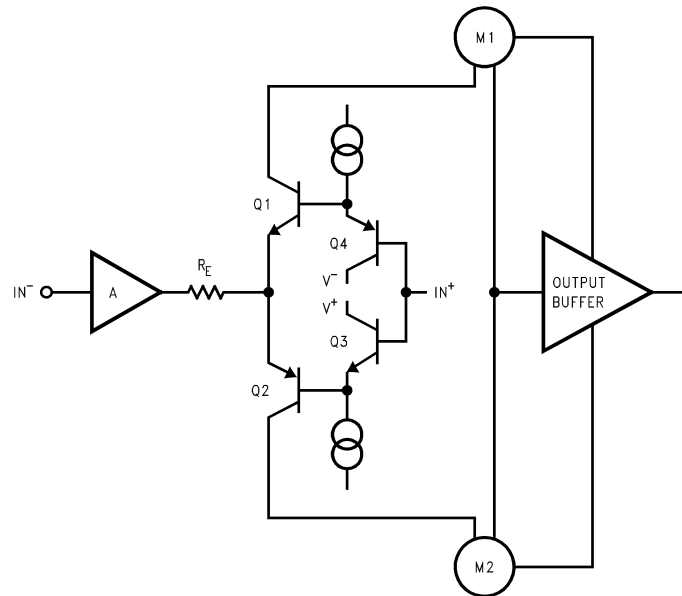

01258155

Application Notes

LM6172 PERFORMANCE DISCUSSION

The LM6172 is a dual high-speed, low power, voltage feedback amplifier. It is unity-gain stable and offers outstanding performance with only 2.3mA of supply current per channel. The combination of 100MHz unity-gain bandwidth, 3000V/ μ s slew rate, 50mA per channel output current and other attractive features makes it easy to implement the LM6172 in various applications. Quiescent power of the LM6172 is 138mW operating at ± 15 V supply and 46mW at ± 5 V supply.

LM6172 CIRCUIT OPERATION

The class AB input stage in LM6172 is fully symmetrical and has a similar slewing characteristic to the current feedback amplifiers. In the LM6172 Simplified Schematic, Q1 through Q4 form the equivalent of the current feedback input buffer, R_E the equivalent of the feedback resistor, and stage A buffers the inverting input. The triple-buffered output stage isolates the gain stage from the load to provide low output impedance.

LM6172 SLEW RATE CHARACTERISTIC

The slew rate of LM6172 is determined by the current available to charge and discharge an internal high impedance node capacitor. This current is the differential input voltage divided by the total degeneration resistor R_E . Therefore, the slew rate is proportional to the input voltage level, and the higher slew rates are achievable in the lower gain configurations.

When a very fast large signal pulse is applied to the input of an amplifier, some overshoot or undershoot occurs. By placing an external series resistor such as 1k Ω to the input of LM6172, the slew rate is reduced to help lower the overshoot, which reduces settling time.

REDUCING SETTling TIME

The LM6172 has a very fast slew rate that causes overshoot and undershoot. To reduce settling time on LM6172, a 1k Ω resistor can be placed in series with the input signal to

decrease slew rate. A feedback capacitor can also be used to reduce overshoot and undershoot. This feedback capacitor serves as a zero to increase the stability of the amplifier circuit. A 2pF feedback capacitor is recommended for initial evaluation. When the LM6172 is configured as a buffer, a feedback resistor of 1k Ω must be added in parallel to the feedback capacitor.

Another possible source of overshoot and undershoot comes from capacitive load at the output. Please see the section "Driving Capacitive Loads" for more detail.

DRIVING CAPACITIVE LOADS

Amplifiers driving capacitive loads can oscillate or have ringing at the output. To eliminate oscillation or reduce ringing, an isolation resistor can be placed as shown in *Figure 1*. The combination of the isolation resistor and the load capacitor forms a pole to increase stability by adding more phase margin to the overall system. The desired performance depends on the value of the isolation resistor; the bigger the isolation resistor, the more damped (slow) the pulse response becomes. For LM6172, a 50 Ω isolation resistor is recommended for initial evaluation.

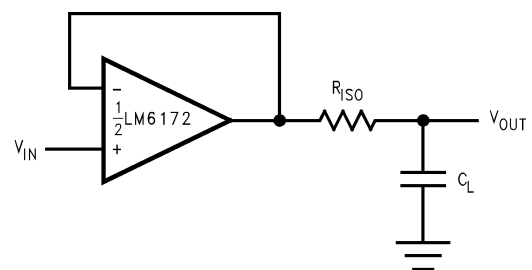

01258145

FIGURE 1. Isolation Resistor Used to Drive Capacitive Load

Application Notes (Continued)

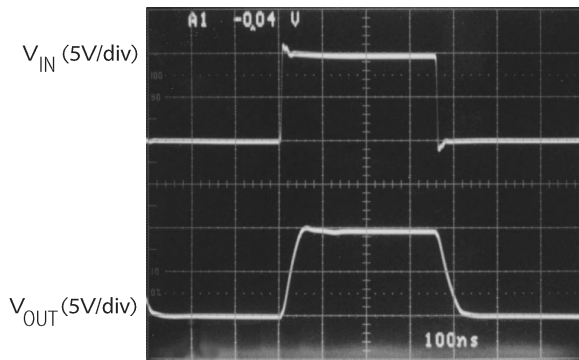

01258151

FIGURE 2. The LM6172 Driving a 510pF Load with a 30Ω Isolation Resistor

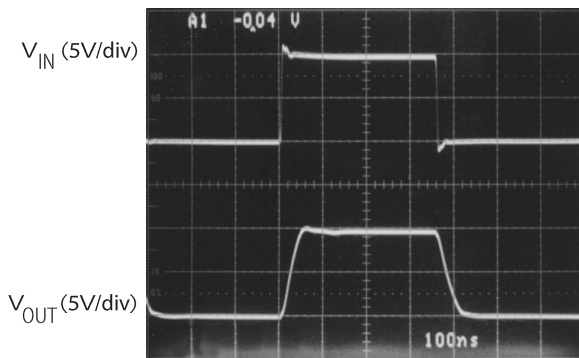

01258152

FIGURE 3. The LM6172 Driving a 220 pF Load with a 50Ω Isolation Resistor

LAYOUT CONSIDERATION

PRINTED CIRCUIT BOARDS AND HIGH SPEED OP AMPS

There are many things to consider when designing PC boards for high speed op amps. Without proper caution, it is very easy to have excessive ringing, oscillation and other degraded AC performance in high speed circuits. As a rule, the signal traces should be short and wide to provide low inductance and low impedance paths. Any unused board space needs to be grounded to reduce stray signal pickup. Critical components should also be grounded at a common point to eliminate voltage drop. Sockets add capacitance to the board and can affect frequency performance. It is better to solder the amplifier directly into the PC board without using any socket.

USING PROBES

Active (FET) probes are ideal for taking high frequency measurements because they have wide bandwidth, high input impedance and low input capacitance. However, the probe ground leads provide a long ground loop that will produce errors in measurement. Instead, the probes can be grounded directly by removing the ground leads and probe jackets and using scope probe jacks.

COMPONENTS SELECTION AND FEEDBACK RESISTOR

It is important in high speed applications to keep all component leads short because wires are inductive at high frequency. For discrete components, choose carbon composition-type resistors and mica-type capacitors. Surface mount components are preferred over discrete components for minimum inductive effect.

Large values of feedback resistors can couple with parasitic capacitance and cause undesirable effects such as ringing or oscillation in high speed amplifiers. For LM6172, a feedback resistor less than 1kΩ gives optimal performance.

COMPENSATION FOR INPUT CAPACITANCE

The combination of an amplifier's input capacitance with the gain setting resistors adds a pole that can cause peaking or oscillation. To solve this problem, a feedback capacitor with a value

$$C_F > (R_G \times C_{IN})/R_F$$

can be used to cancel that pole. For LM6172, a feedback capacitor of 2pF is recommended. *Figure 4* illustrates the compensation circuit.

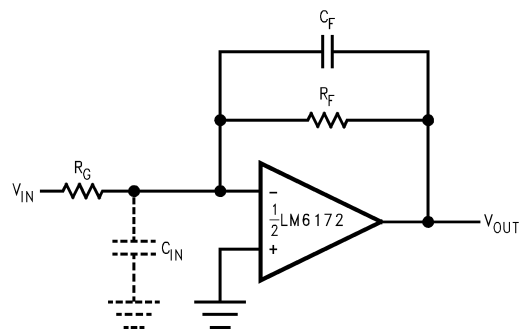

01258146

FIGURE 4. Compensating for Input Capacitance

Application Notes (Continued)

POWER SUPPLY BYPASSING

Bypassing the power supply is necessary to maintain low power supply impedance across frequency. Both positive and negative power supplies should be bypassed individually by placing 0.01 μ F ceramic capacitors directly to power supply pins and 2.2 μ F tantalum capacitors close to the power supply pins.

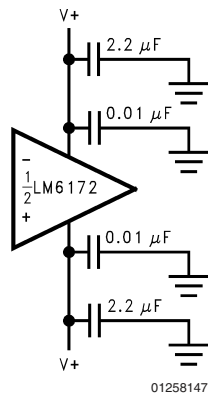

FIGURE 5. Power Supply Bypassing

TERMINATION

In high frequency applications, reflections occur if signals are not properly terminated. Figure 6 shows a properly terminated signal while Figure 7 shows an improperly terminated signal.

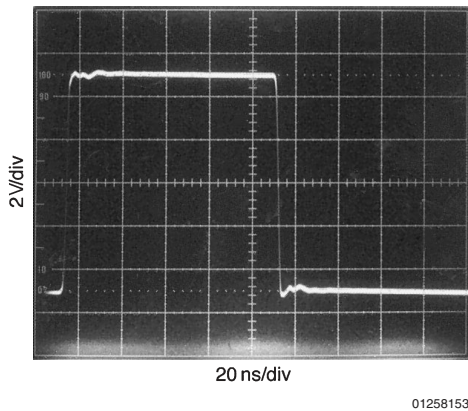

FIGURE 6. Properly Terminated Signal

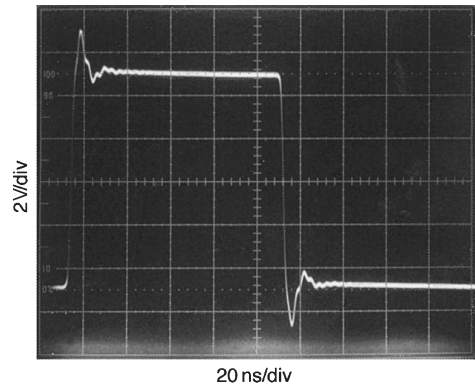

FIGURE 7. Improperly Terminated Signal

To minimize reflection, coaxial cable with matching characteristic impedance to the signal source should be used. The other end of the cable should be terminated with the same value terminator or resistor. For the commonly used cables, RG59 has 75 Ω characteristic impedance, and RG58 has 50 Ω characteristic impedance.

POWER DISSIPATION

The maximum power allowed to dissipate in a device is defined as:

$$P_D = (T_{J(max)} - T_A)/\theta_{JA}$$

Where P_D is the power dissipation in a device

$T_{J(max)}$ is the maximum junction temperature

T_A is the ambient temperature

θ_{JA} is the thermal resistance of a particular package

For example, for the LM6172 in a SO-8 package, the maximum power dissipation at 25 $^{\circ}$ C ambient temperature is 780mW.

Thermal resistance, θ_{JA} , depends on parameters such as die size, package size and package material. The smaller the die size and package, the higher θ_{JA} becomes. The 8-pin DIP package has a lower thermal resistance (95 $^{\circ}$ C/W) than that of 8-pin SO (160 $^{\circ}$ C/W). Therefore, for higher dissipation capability, use an 8-pin DIP package.

The total power dissipated in a device can be calculated as:

$$P_D = P_Q + P_L$$

P_Q is the quiescent power dissipated in a device with no load connected at the output. P_L is the power dissipated in the device with a load connected at the output; it is not the power dissipated by the load.

Furthermore,

P_Q : = supply current x total supply voltage with no load

P_L : = output current x (voltage difference between supply voltage and output voltage of the same supply)

For example, the total power dissipated by the LM6172 with $V_S = \pm 15V$ and both channels swinging output voltage of 10V into 1k Ω is

$$P_D: = P_Q + P_L$$

$$: = 2[(2.3mA)(30V)] + 2[(10mA)(15V - 10V)]$$

$$: = 138mW + 100mW$$

$$: = 238mW$$

Application Circuits

I-to-V Converters

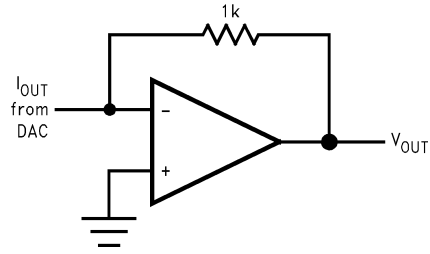

01258148

Differential Line Driver

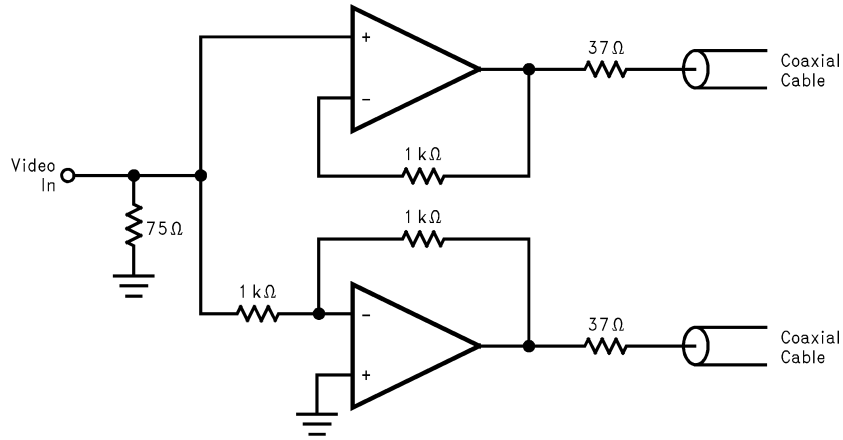

01258149

Physical Dimensions inches (millimeters) unless otherwise noted

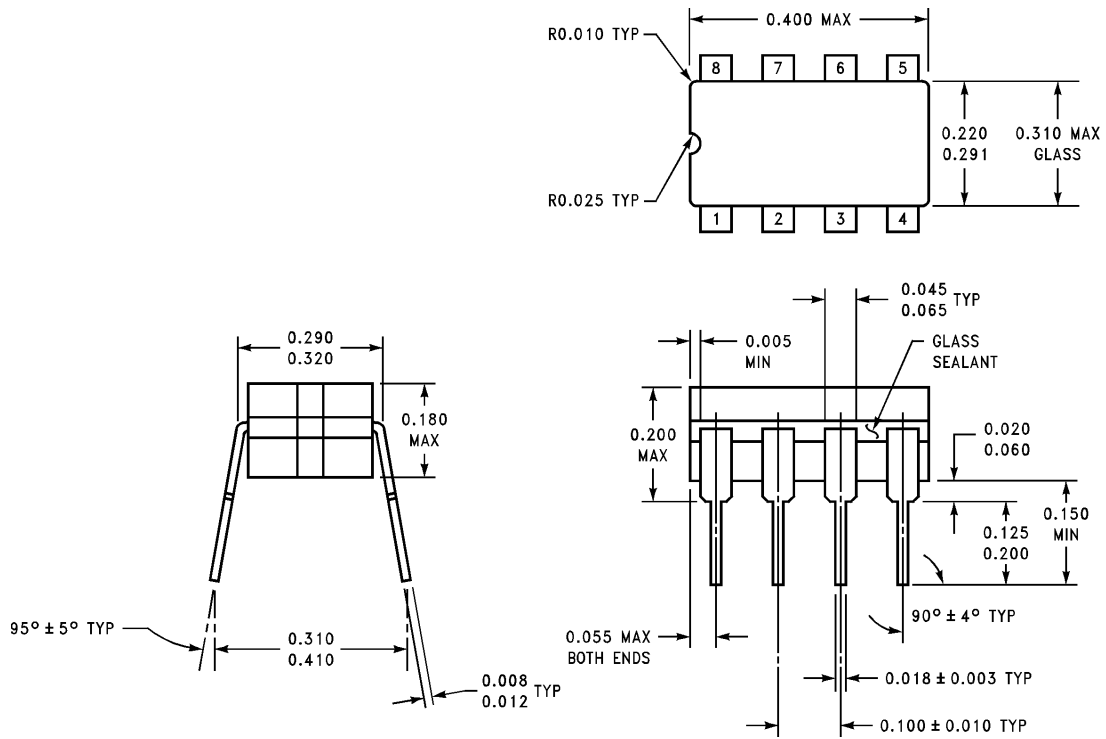

J08A (REV K)

8-Lead Ceramic Dual-In-Line Package
 Order Number LM6172AMJ-QML or 5962-9560401QPA
 NS Package Number J08A

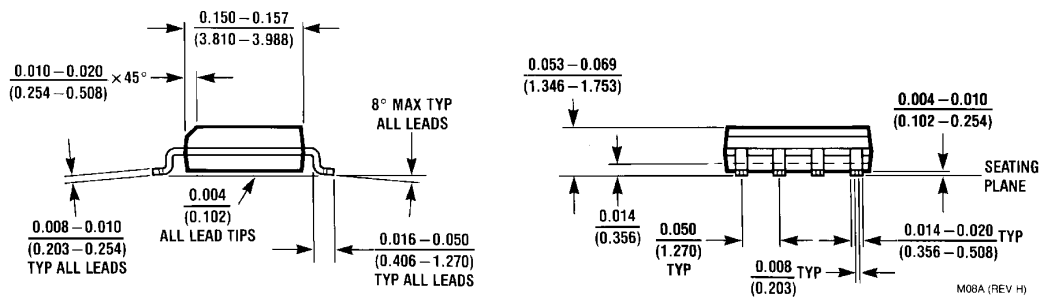
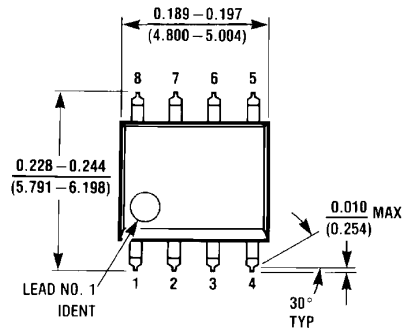

M08A (REV H)

8-Lead (0.150" Wide) Molded Small Outline Package, JEDEC
 Order Number LM6172IM or LM6172IMX
 NS Package Number M08A

Physical Dimensions inches (millimeters) unless otherwise noted (Continued)

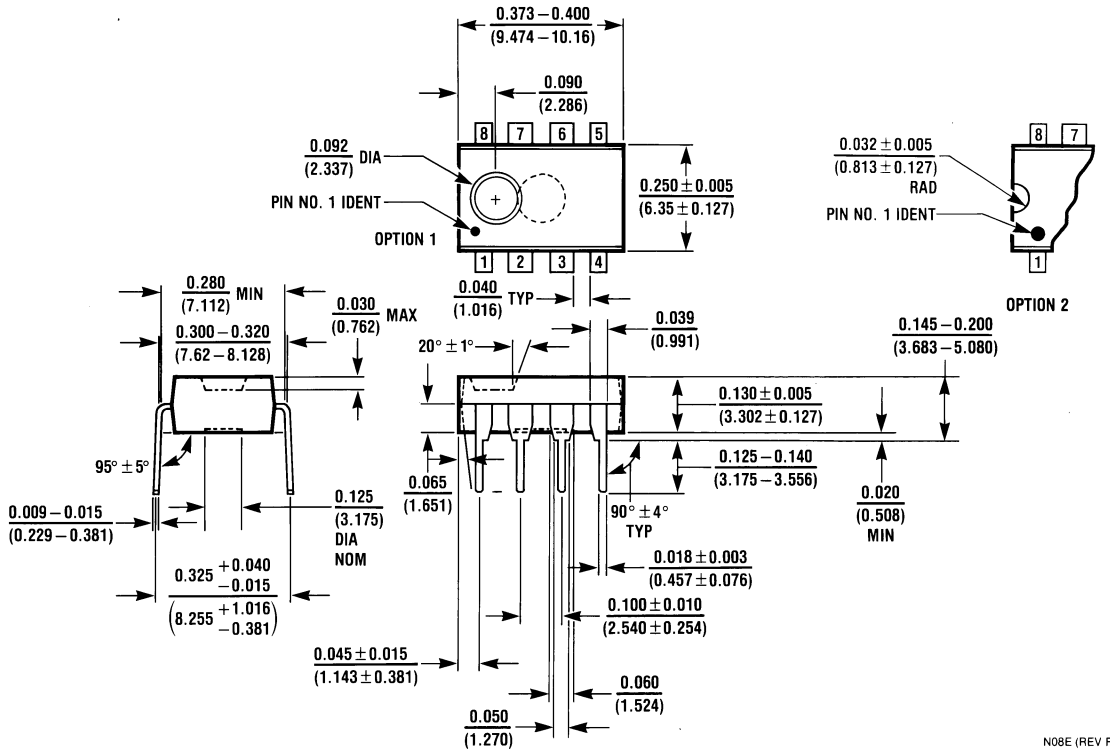

8-Lead (0.300" Wide) Molded Dual-In-Line Package
Order Number LM6172IN
NS Package Number N08E

N08E (REV F)

LIFE SUPPORT POLICY

NATIONAL'S PRODUCTS ARE NOT AUTHORIZED FOR USE AS CRITICAL COMPONENTS IN LIFE SUPPORT DEVICES OR SYSTEMS WITHOUT THE EXPRESS WRITTEN APPROVAL OF THE PRESIDENT AND GENERAL COUNSEL OF NATIONAL SEMICONDUCTOR CORPORATION. As used herein:

1. Life support devices or systems are devices or systems which, (a) are intended for surgical implant into the body, or (b) support or sustain life, and whose failure to perform when properly used in accordance with instructions for use provided in the labeling, can be reasonably expected to result in a significant injury to the user.
2. A critical component is any component of a life support device or system whose failure to perform can be reasonably expected to cause the failure of the life support device or system, or to affect its safety or effectiveness.



National Semiconductor
Americas Customer
Support Center
 Email: new.feedback@nsc.com
 Tel: 1-800-272-9959

National Semiconductor
Europe Customer Support Center
 Fax: +49 (0) 180-530 85 86
 Email: europe.support@nsc.com
 Deutsch Tel: +49 (0) 69 9508 6208
 English Tel: +44 (0) 870 24 0 2171
 Français Tel: +33 (0) 1 41 91 8790

National Semiconductor
Asia Pacific Customer
Support Center
 Fax: +65-6250 4466
 Email: ap.support@nsc.com
 Tel: +65-6254 4466

National Semiconductor
Japan Customer Support Center
 Fax: 81-3-5639-7507
 Email: jpn.feedback@nsc.com
 Tel: 81-3-5639-7560

www.national.com